



GS4 Grandstands Technical Data

Description

A complete proprietary system including heavy duty aluminium support frames and anodised aluminium seat plank with cast aluminium end caps.

Aluminium Seat Section

Extruded aluminium alloy (6060-T5) seat plank 250mm wide with two longitudinal flanged ribs as part of the extrusion. The longitudinal ribs run continuously for the length of the seat and provide fastening for the support frames – Nominal wall thickness – 2.5mm – Finish – Clear anodised 15 microns.

Seat End Caps

Manufactured from cast aluminium to fit seat extrusion – Finish – as cast or powder coated – Manufacturers name cast into end cap. Fit end caps using two (2) x 4.8mm aluminium pop rivets through the underside longitudinal flanges.

Support Frames

Fabricated from 100 x 50 x 3mm RHS (6060-T5), 100 x 10mm flat bar (6060-T5), 25 x 3 tube (6060-T5) and 50 x 50 x 2.5mm SHS (6060-T5). The frames are welded according to (AS-1554) – Finish – as extruded.

Handrail and Supporting Posts

Fabricated from 50 x 25 x 3mm RHS (6060 T5), 20 x 16mm tube (6060 T5), 50 x 50 x 4mm SHS (6060T5) and 100 x 10mm flat bar (6060 T5). The rails and posts are welded according to (AS-1554) – Finish – as extruded or powder coated.

Safety Grab Rails

Fabricated from 50 x 3mm Tube (6060-T4) and 6mm Sheet (6060-T5). The Safety Grab Rails are welded according to (AS-1554) – Finish – powder coated.

Safety Access Steps

Fabricated from 3mm Treadplate (6060-T5). The Safety Access Steps are welded according to (AS-1554) . Finish – as rolled. All steps have a Stair Tread Bullnose attached - “ Anti-slip and Sight Impaired compliant to (AS: 1428.1-2009) “

Installation

GS4 Grandstands **must** be fitted to a concrete slab. Please refer to our concrete footing ‘Minimum Recommendations’

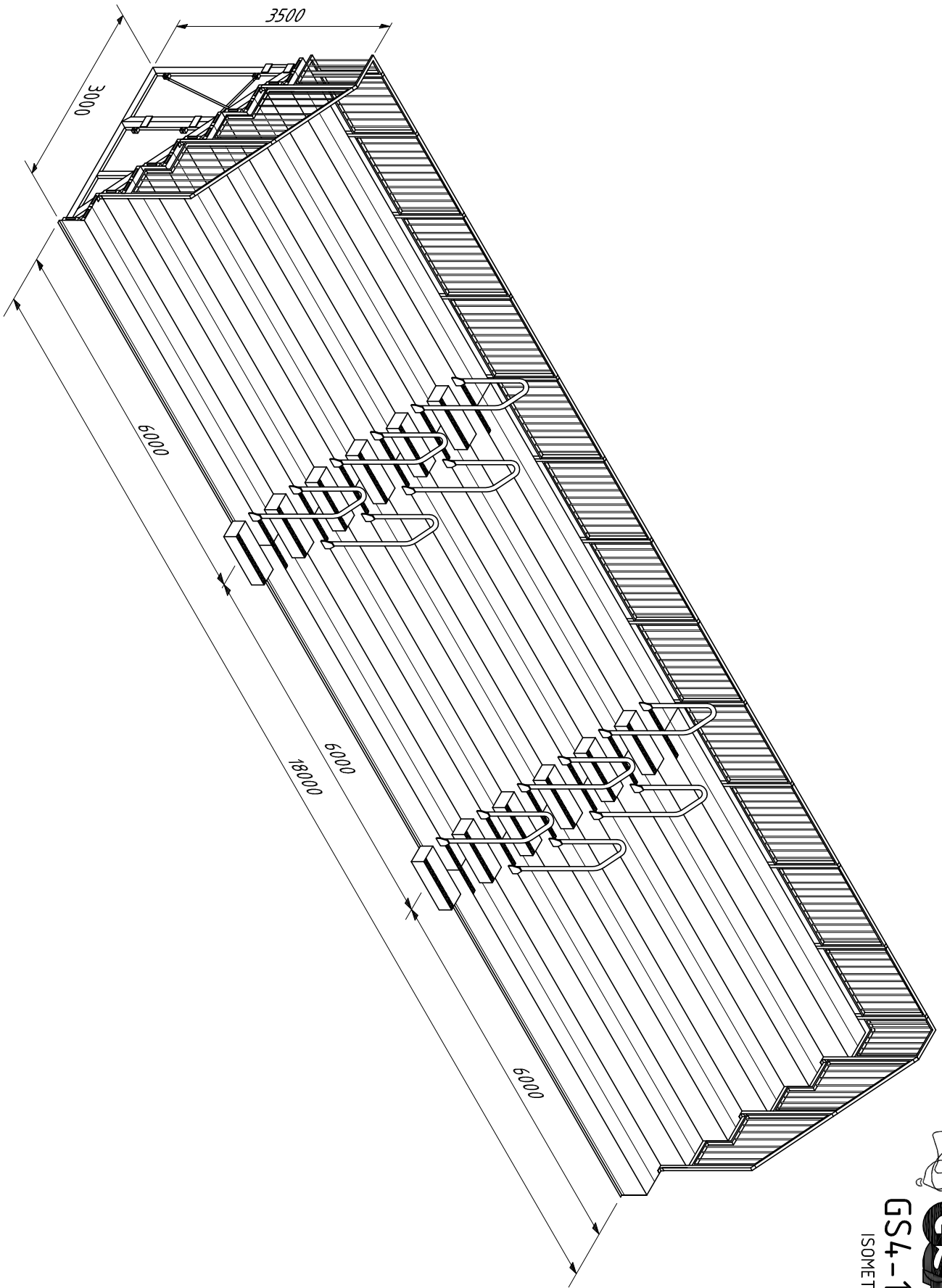

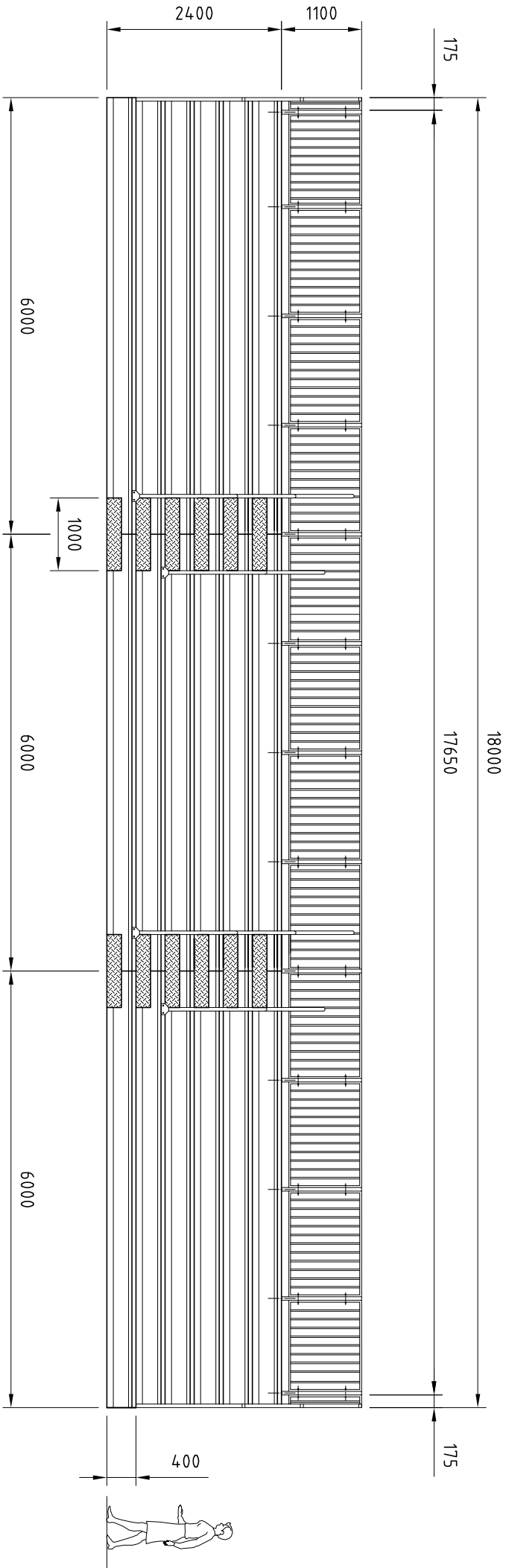

GSA
GRANDSTANDS
AUSTRALIA
GS4-18m6t
ISOMETRIC

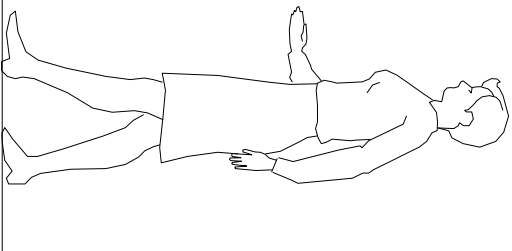
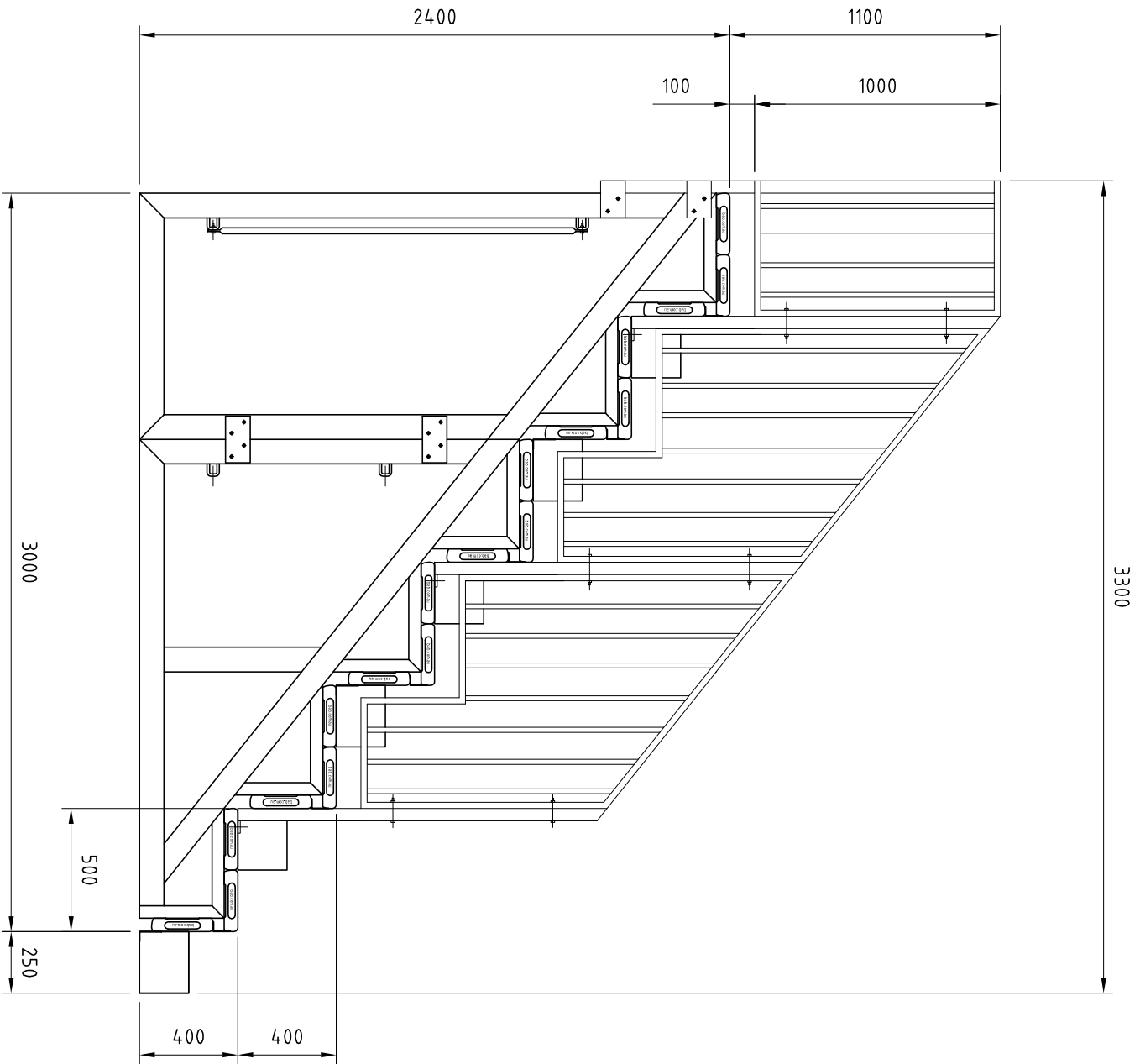

GS4-18m6+

FRONT ELEVATION



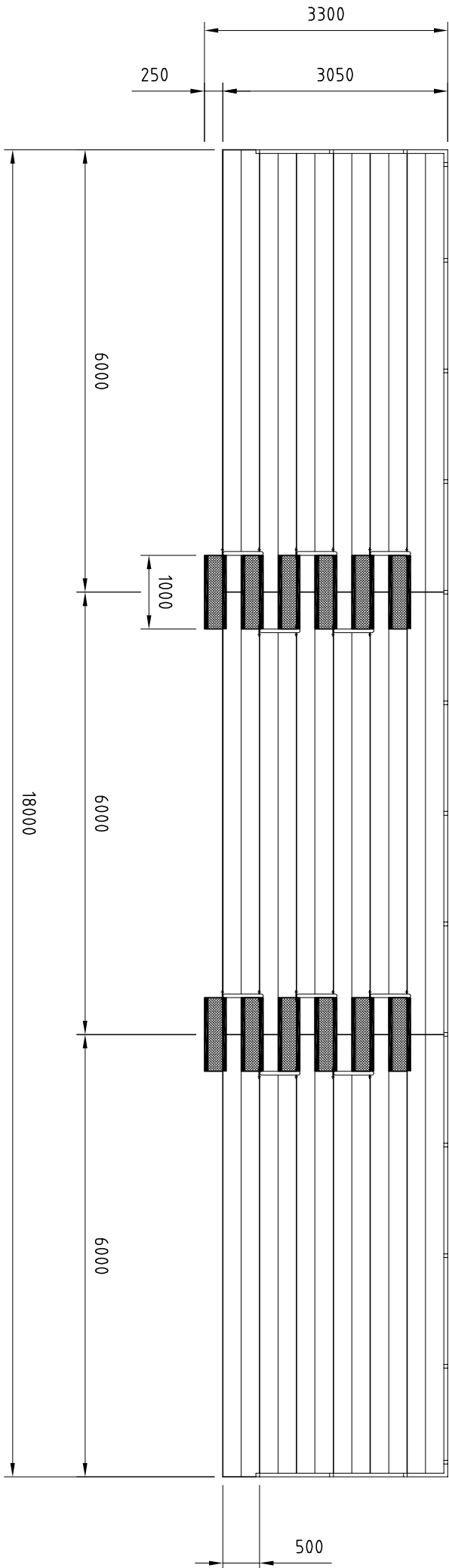

CSA
 GRANDSTANDS
 AUSTRALIA

GS4-18m6t
 SIDE ELEVATION

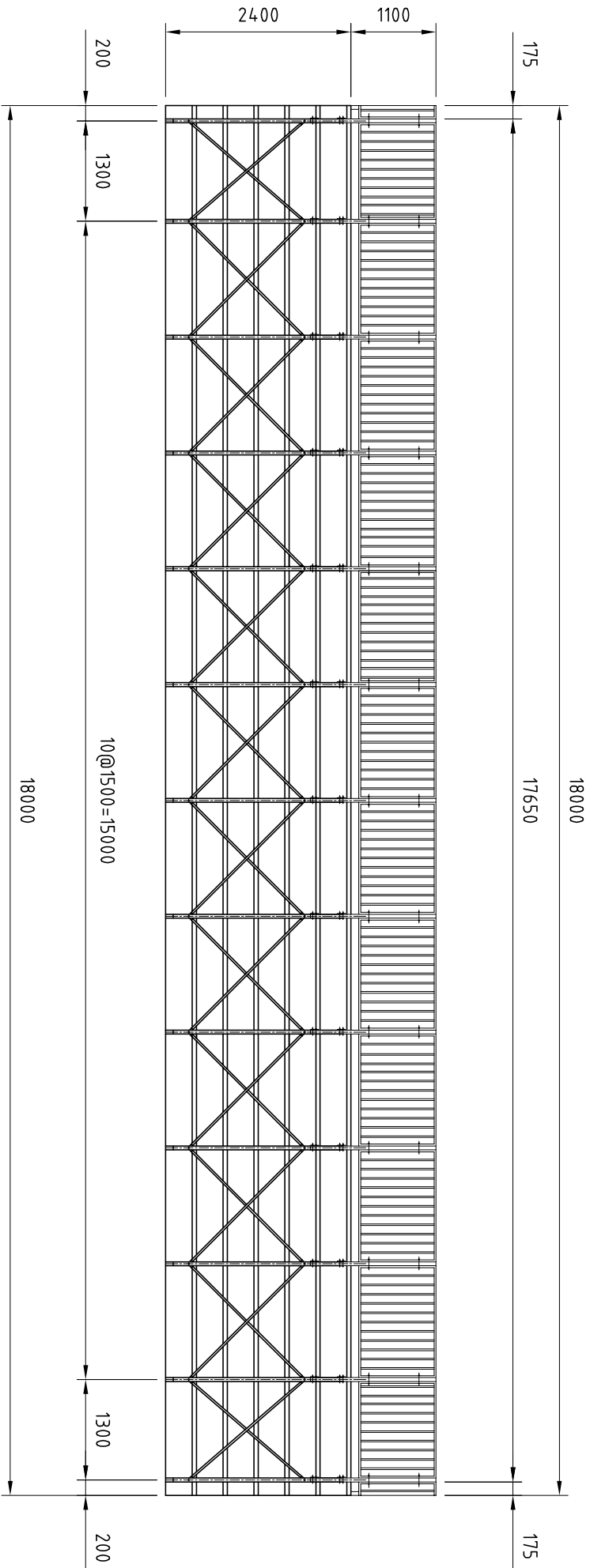

GS4-18m6t

PLAN VIEW



GS4-18m6t

REAR ELEVATION