



GS3 SERIES ALUMINIUM GRANDSTANDS

Description

A complete proprietary system including heavy duty aluminium support frames and anodised aluminium seat plank with cast aluminium end caps.

Aluminium Seat Section

Extruded aluminium alloy (6060-T5) seat plank 250mm wide with two longitudinal flanged ribs as part of the extrusion. The longitudinal ribs run continuously for the length of the seat and provide fastening for the support frames - Nominal wall thickness – 2.5mm - Finish – Clear anodised 15 microns or Decowood

Support Frames

Fabricated from 50 x 50 x 6mm angle (6060-T5), 100 x 10mm flat bar (6060-T5). The frames are welded according to (AS-1554) - Finish – as extruded or powder coated.

Seat End Caps

Manufactured from cast aluminium to fit seat extrusion - Finish – as cast or powder coated - Manufacturers name cast into end cap

Assembly

Fit end caps using two (2) x 4.8mm aluminium pop rivets through the underside longitudinal flanges Fit support frames using two (2) x 25 x 6mm (minimum) zinc-plated bolts with nylon insert nuts through the underside longitudinal flanges.

Installation

The stands are freestanding – however for security the stands have 2 x 12mm holes in each base frame which can be used to skew-peg on grass or dyna-bolt to concrete.

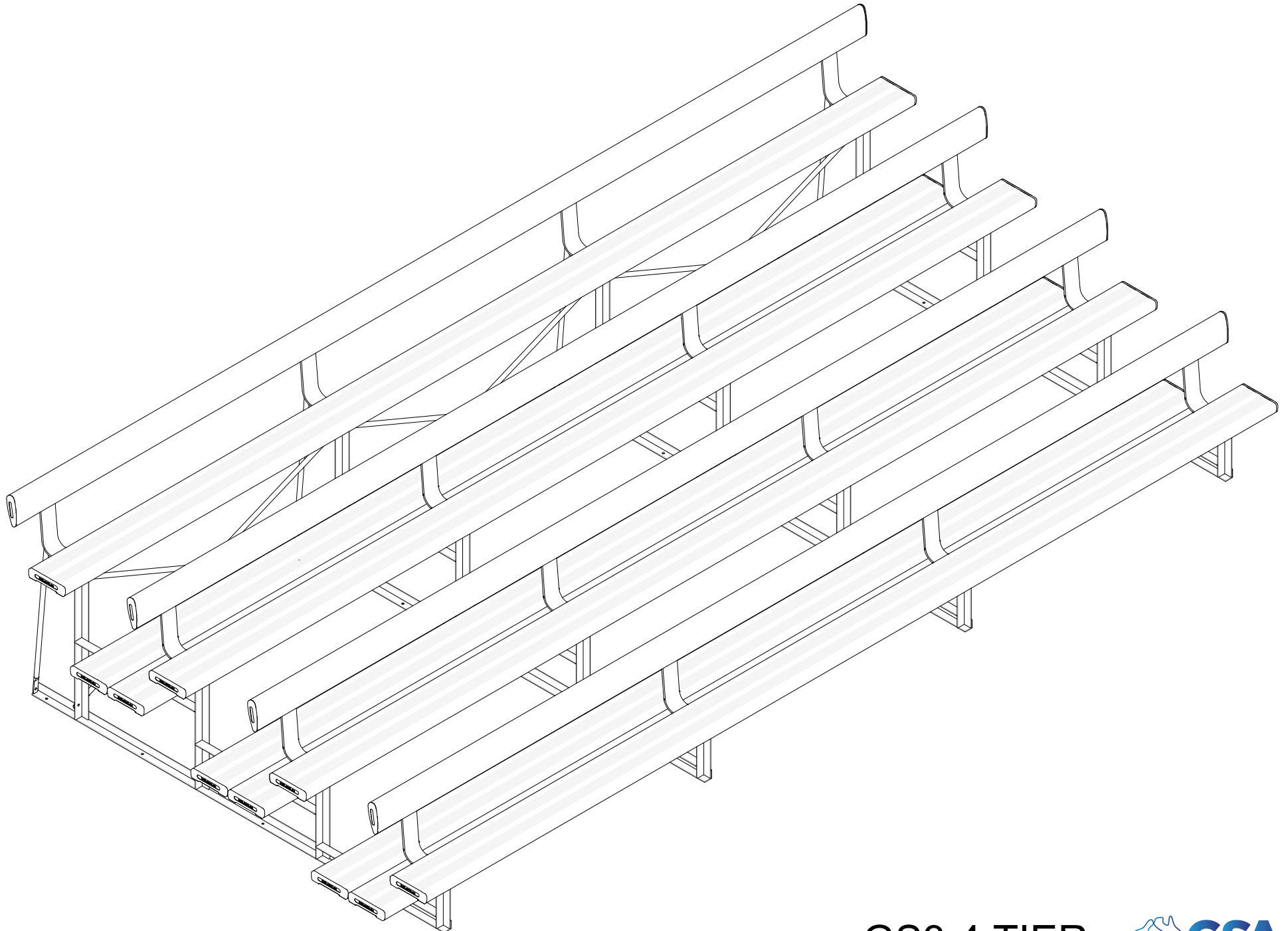

GS3 4 TIER



GS3 2 TIER 1:20

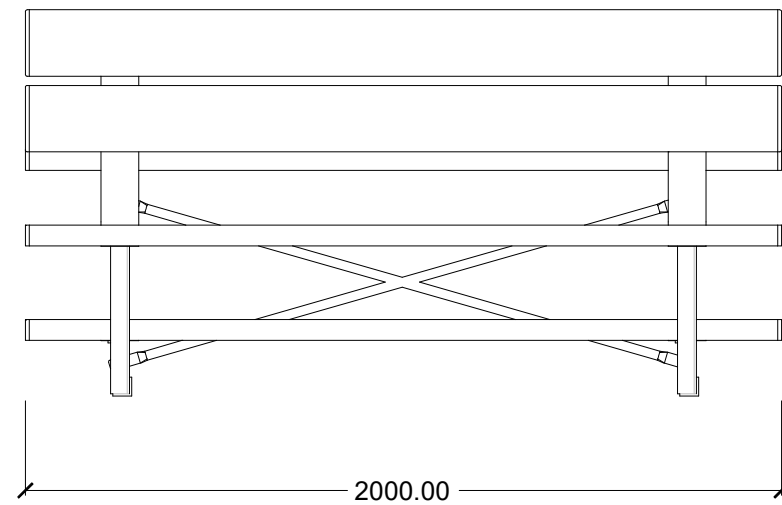
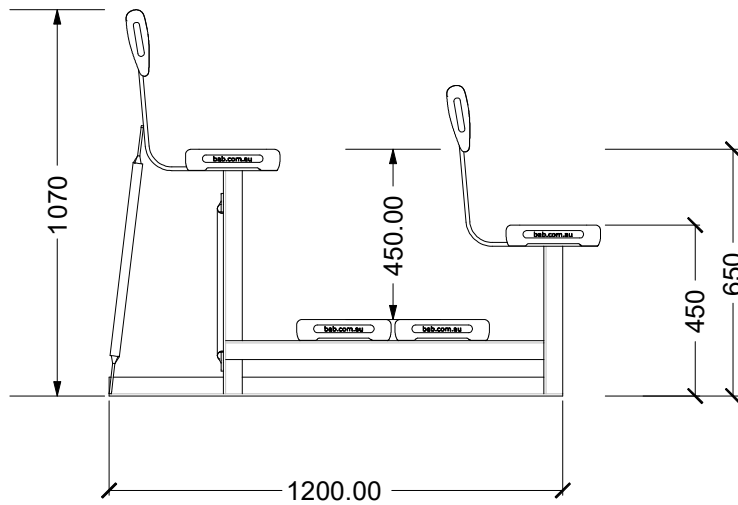
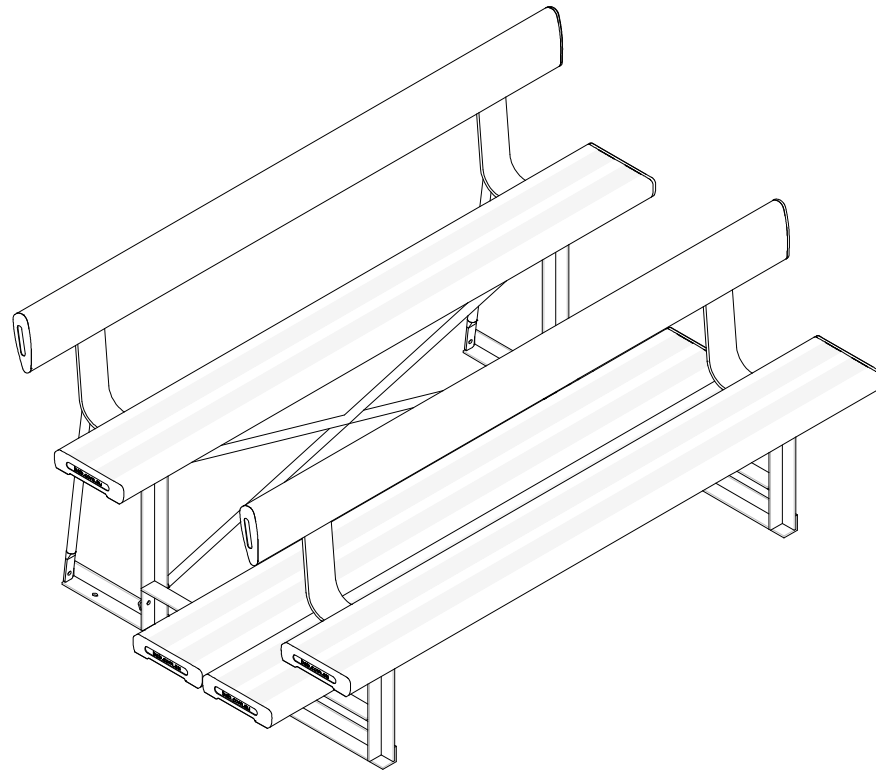

2000, 3000, 4000 or 6000 AVAILABLE

GS3 3 TIER 1:25

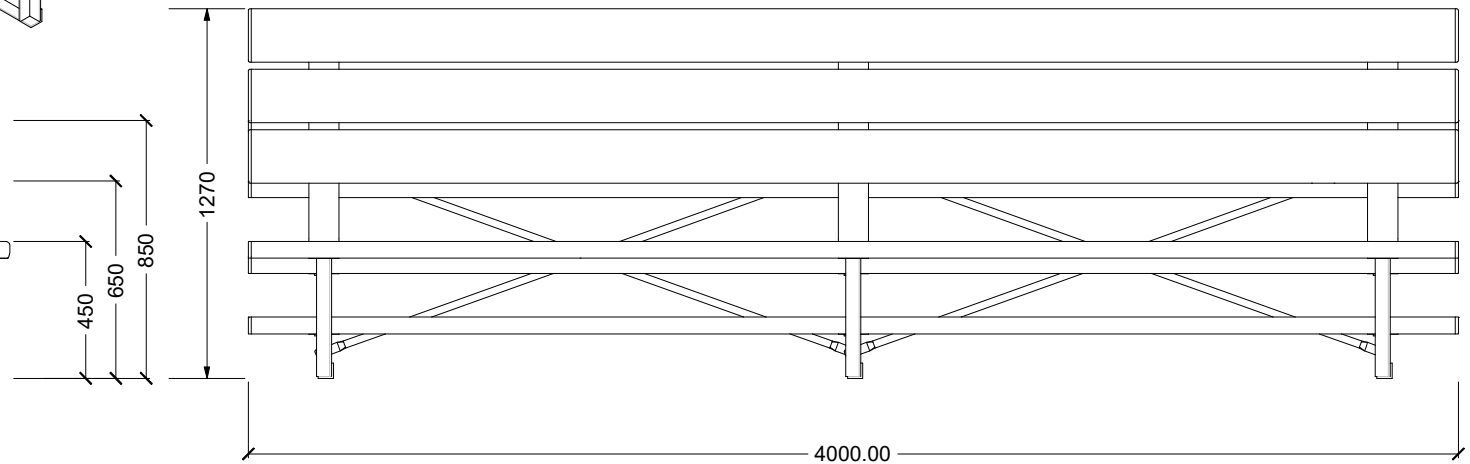
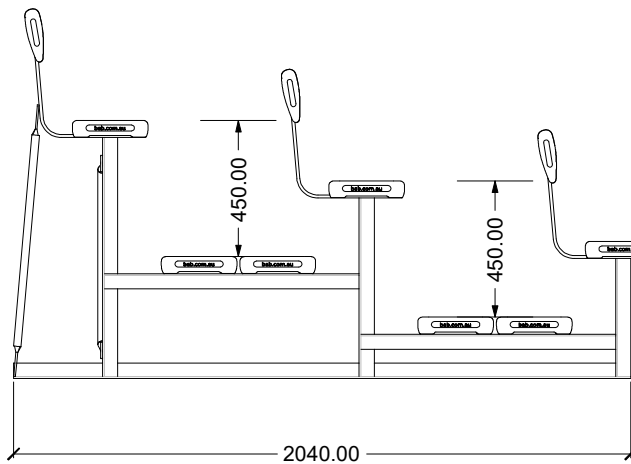
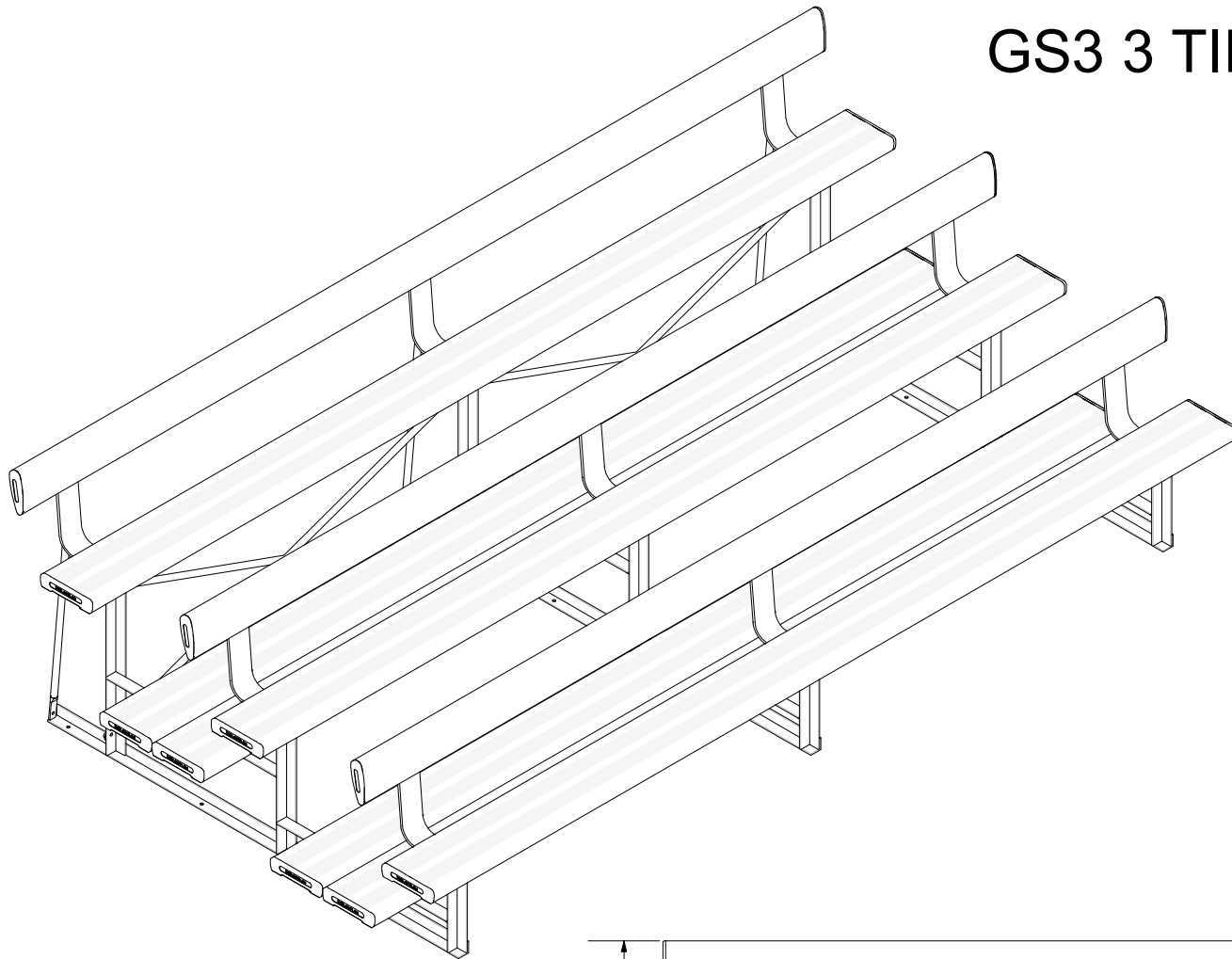

2000, 3000, 4000 or 6000 AVAILABLE

GS3 4 TIER 1:25

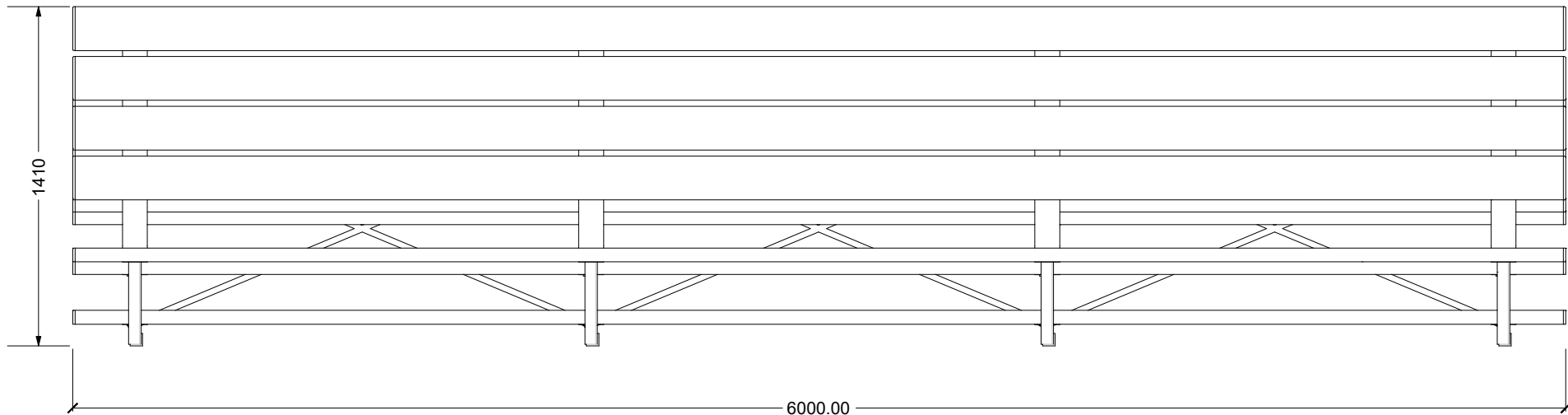
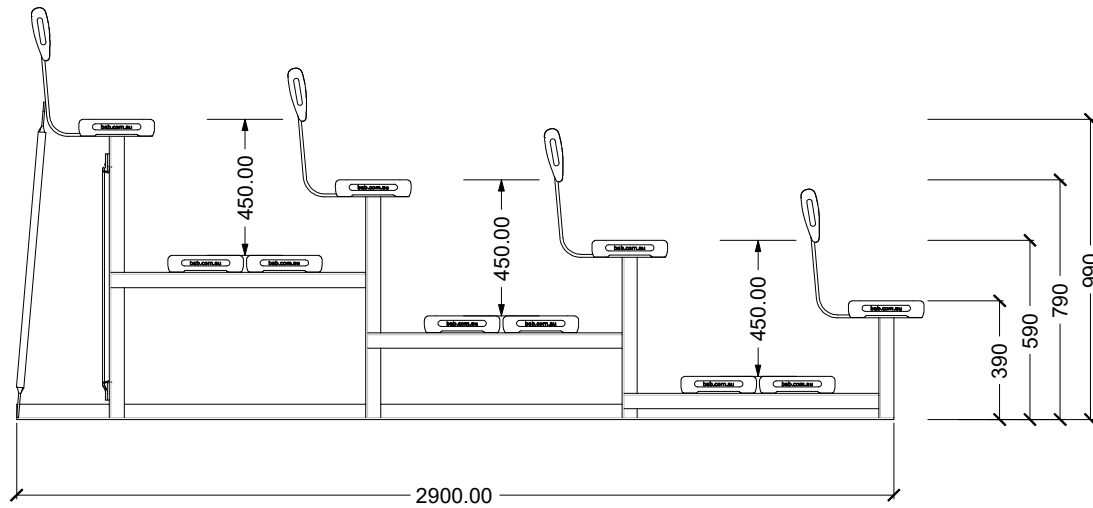

6000.00
2000, 3000, 4000 or 6000 AVAILABLE